

4

3

2

1

B

B

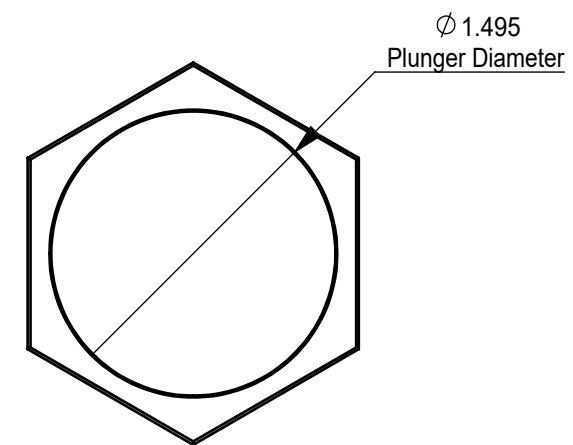
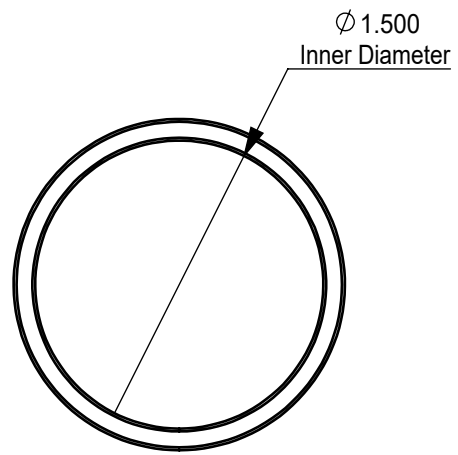
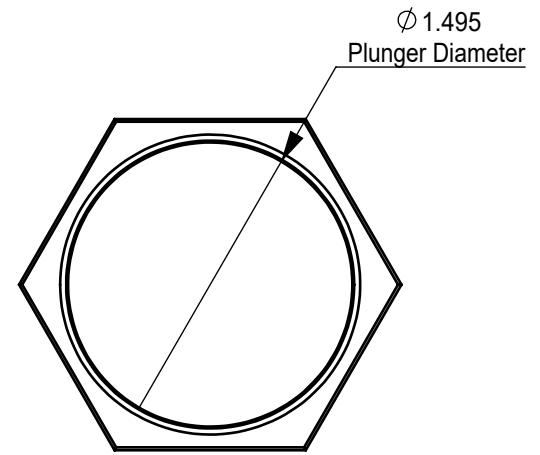
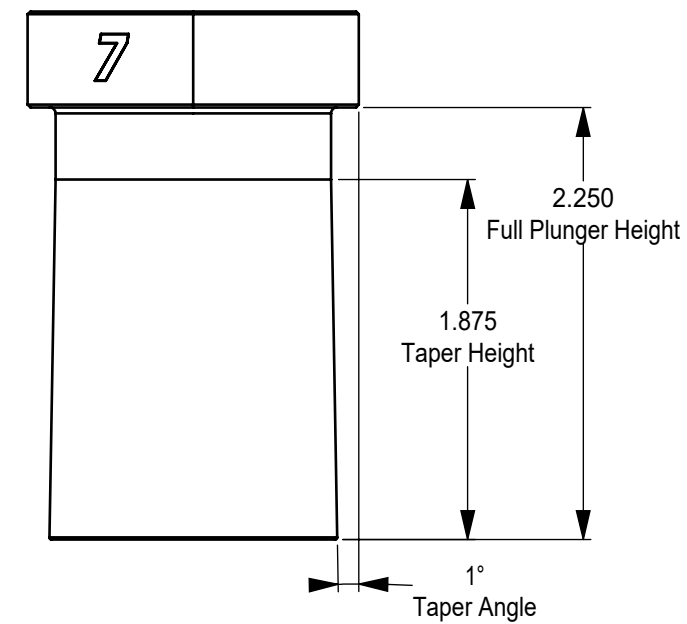
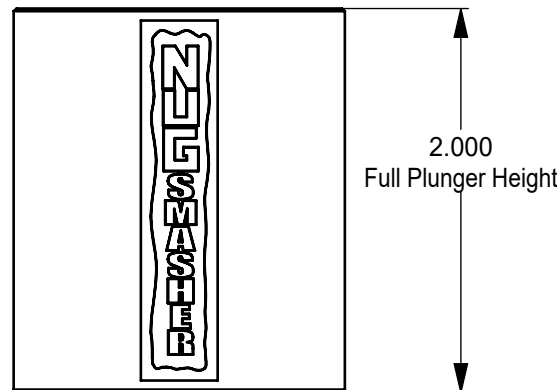
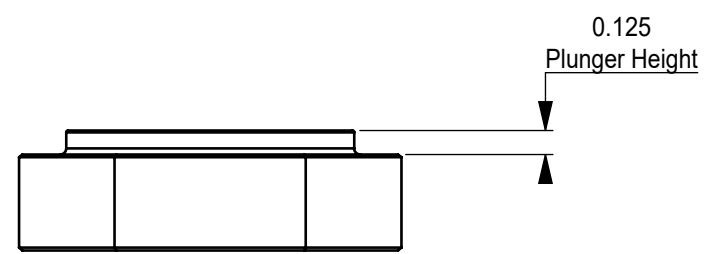

A



A

4

3

2

1

 PMG Manufacturing PMG COS AZ, LLC. PROPRIETARY AND CONFIDENTIAL <small>THE INFORMATION CONTAINED IN THIS DRAWING IS THE SOLE PROPERTY OF Premiere Manufacturing/PMG Multirotors. ANY REPRODUCTION IN PART OR AS A WHOLE WITHOUT THE WRITTEN PERMISSION OF Premiere Manufacturing/PMG Multirotors IS STRICTLY PROHIBITED.</small>	Scale:	1:1	 Pre-Press Mold
	Sheet:	1 of 1	
	Material:	6061 T-6 Aluminum (Aircraft Grade)	7g Round